

Application of Multi-Antenna GPS Technology in Monitoring Stability of Slopes

XL Ding, WJ Dai, WT Yang, XW Zhou, J Lam,
The Kong Hong Polytechnic University

Q Zhang, L Wang
Chang'An University

GPS and Slope Monitoring

- There are many unstable slopes
- Monitoring the progressive movement of slopes is important for preventing unexpected slope failures
- Conventional GPS technology is considered too expensive for monitoring slopes
- Multi-antenna GPS provides a solution to the problem

Multi-Antenna GPS: Basic Concept

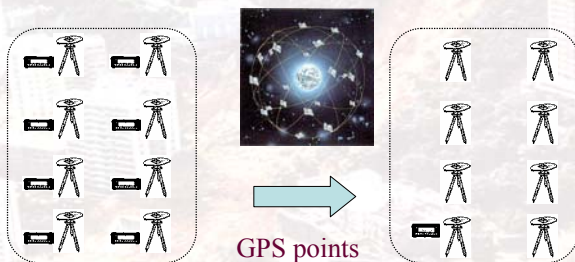

Standard GPS

Multi-antenna GPS

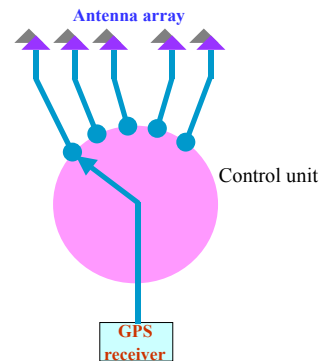

Multi-Antenna GPS: System Components

- 1) GPS receivers and antennas
- 2) Control unit
- 3) Communication system
- 4) Software
- 5) Power supply

Multi-Antenna GPS: System Components

- 1) GPS receivers and antennas
 - Any standard receivers and antennas can be used with the system
 - One or more receivers as reference station(s)
 - One receiver as rover station that is linked to the antenna array

Multi-Antenna GPS: System Components

2) Control unit

- Automatically connects to the rover receiver to different antennas



Multi-Antenna GPS: System Components

3) Communication system

- Functions as data link between a slope site and the office
- Controls the operation of the system and transmits data from site to office
- Any standard systems can be used, e.g., GPRS, GSM, fixed line or wireless internet



Multi-Antenna GPS: System Components

4) Software for system control, data management and processing

- Controls system operation
- Data management
- Data processing
- Visualisation of results

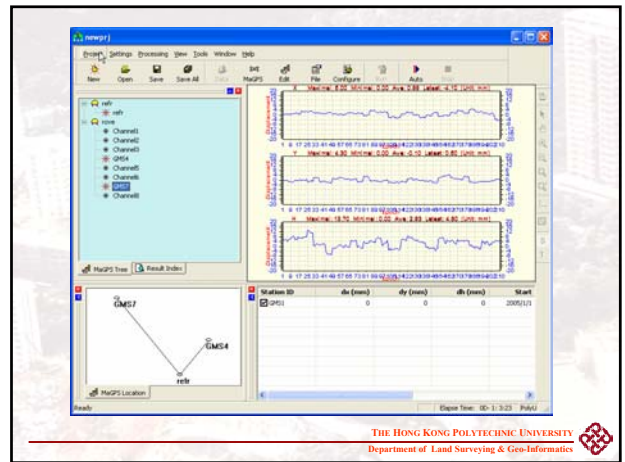

Station position map

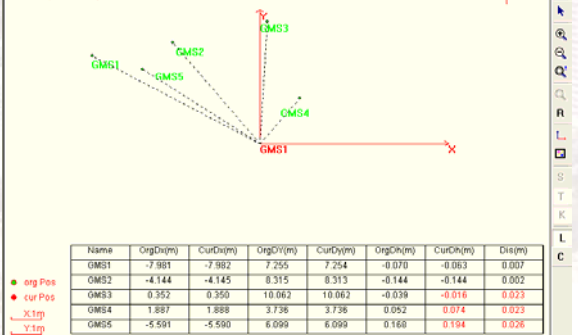

Overview of System Structure

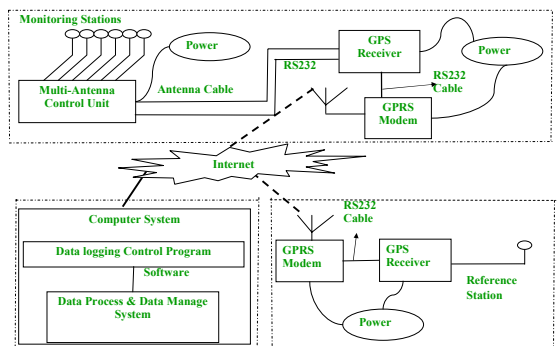

Illustration of a Reference Station



Illustration of a Monitoring Station



Advantages of Multi-Antenna GPS

- A much more economical multi-point monitoring system
 - Two receivers for monitoring many points
 - Savings in power supply
 - Savings in data communication
 - Savings in site formation and installation
- When a landslide occurs, only antennas are lost, not the receivers

Disadvantages of Multi-Antenna GPS

- Not real-time measurements for all the monitored points
- Antenna cable lengths are limited

Test and Application Examples (1)

1) Controlled test

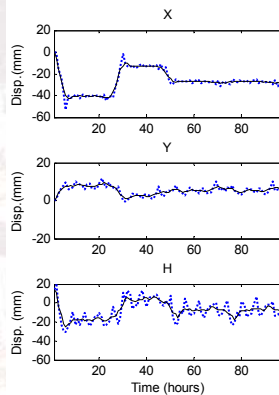

- Four days of data
- Data sampling rate: once every 5 s
- One solution every hour

Test and Application Examples (2)

2) Results from a roadside slope

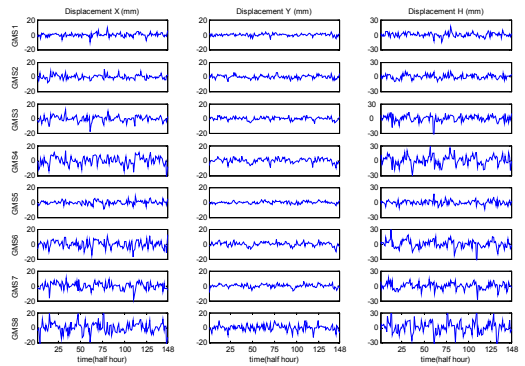
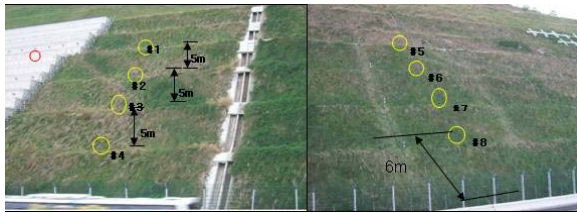

30-minute measurement series

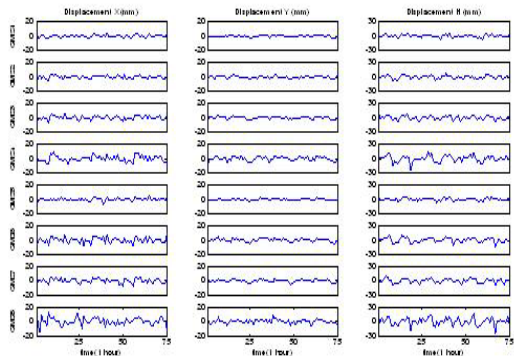

One-hour measurement series

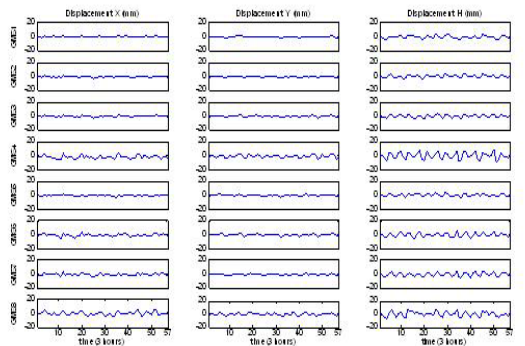

Three-hour measurement series

Table2. RMS values of the coordinate series (interval=30min) (unit: mm)

RMS value	GMS1	GMS2	GMS3	GMS4	GMS5	GMS6	GMS7	GMS8	Average
X	2.5	3.0	4.0	5.9	2.7	5.1	4.6	7.4	4.4
Y	1.7	2.2	2.2	3.0	1.6	2.7	2.3	3.7	2.4
H	4.2	4.5	6.8	9.8	4.4	8.1	6.7	12.5	7.1

Table3. RMS value of the coordinate series (interval=1hour) (unit: mm)

RMS value	GMS1	GMS2	GMS3	GMS4	GMS5	GMS6	GMS7	GMS8	Average
X	1.8	2.2	2.8	4.2	2.0	4.0	3.3	5.1	3.2
Y	1.2	1.7	1.7	2.7	1.3	2.2	1.8	2.9	1.9
H	2.8	3.4	4.1	6.6	2.8	5.0	4.5	7.7	4.6

Table4. RMS value of the coordinate series (interval=3hour) (unit: mm)

RMS value	GMS1	GMS2	GMS3	GMS4	GMS5	GMS6	GMS7	GMS8	Average
X	0.9	1.2	1.3	3.2	1.2	2.1	1.9	2.4	1.8
Y	0.9	1.0	1.2	2.3	1.1	1.4	1.2	1.9	1.4
H	2.1	2.0	2.1	4.7	1.9	2.9	2.7	3.8	2.8

Conclusions

- Multi-antenna GPS is an economical and effective solution for applications such as landslide monitoring
- Results from controlled tests and applications of the technology have shown that millimeter level of measurement accuracy can be routinely achieved

Acknowledgements

- The research was supported by
 - The Hong Kong Polytechnic University
 - Research Grants Council (RGC) of the Hong Kong Special Administrative Region Government